

5	4	3	2	1
1720	1935	2150	2365	2580
-	-	-	-	-
1866	2100	2333	2566	2800
205°	230°	255°	280°	305°

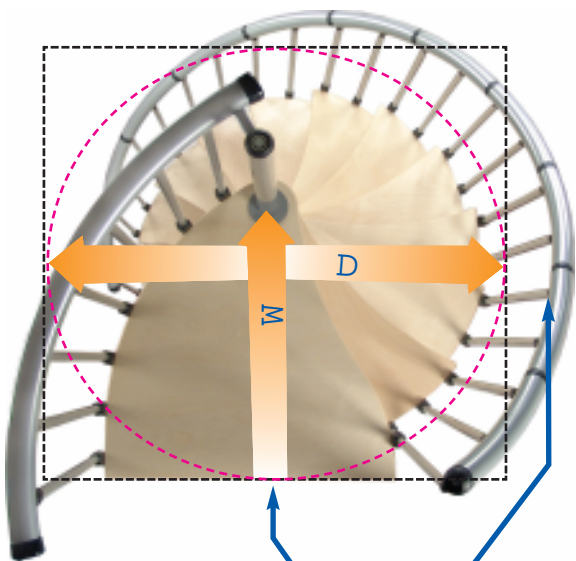

W	D
650-700 mm	>1370 mm

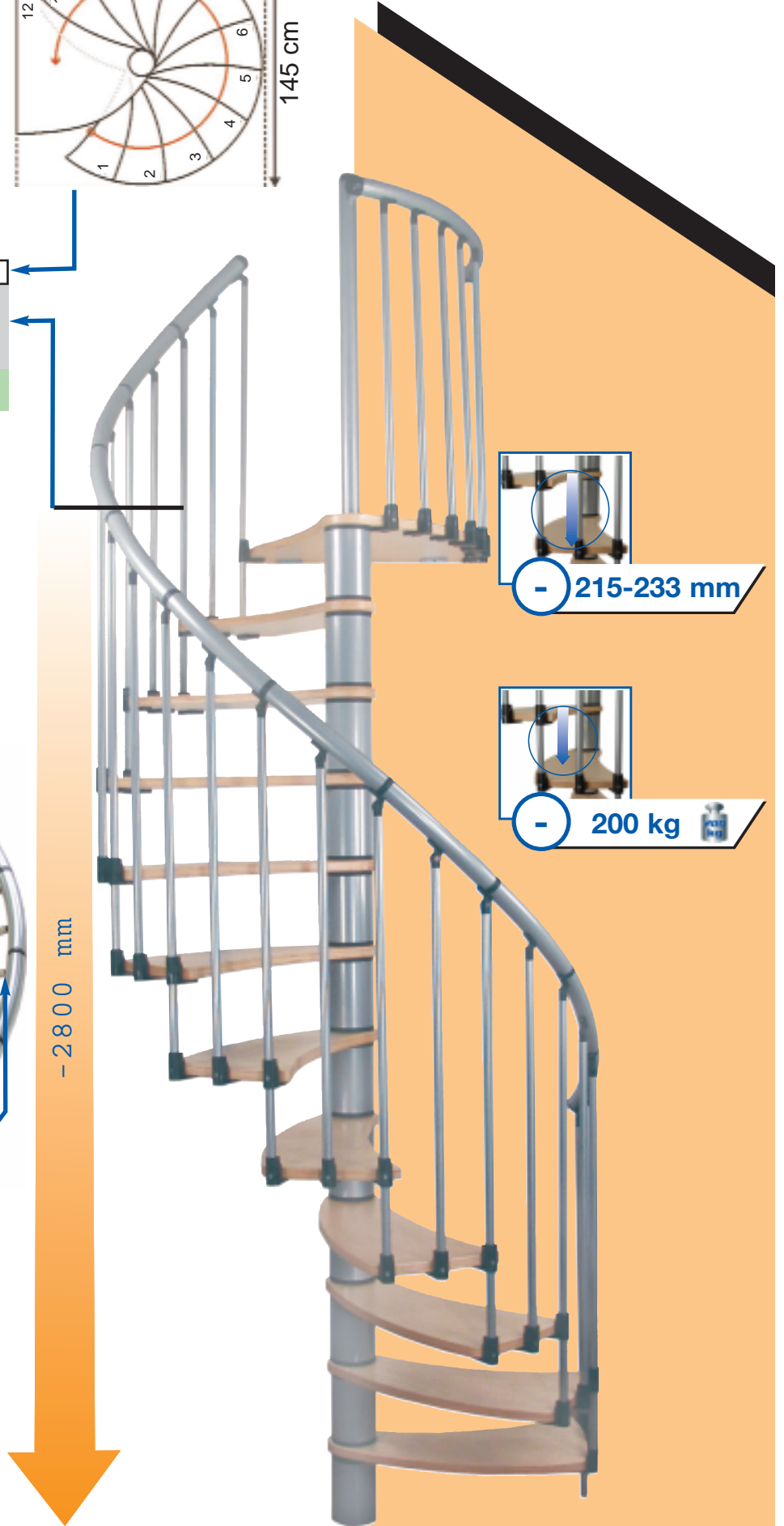

- 215-233 mm

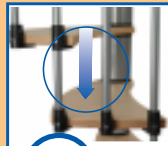

- 200 kg 

	W1	1 x - 931123 1 x - 932128		W15	1 x - 931883
	W2	11 x - 932122 11 x - 932127		W16	2 x - 930654
	W3	1 x - 920924		W17	5 x - 930706
	W4	1 x - 931881		W18	2 x - 932121
	W5	1 x - 920915		W19	96 x - 930698
	W6	1 x - 931886		W20	42 x - 932032
	W7	8 x - 932118		W21	30 x - 932031
	W8	23 x - 932119		W22	2 x - 930623
	W9	12 x - 931889		W23	30 x - 931217
	W10	1 x - 932120		W24	18 x - 932137
	W11	14 x - 932124 14 x - 932129		W25	1 x - 921059
	W14	2 x - 931884		W26	10 x - 930304
				W27	1 x - 930687
				W28	32 x - 930631

ø35 mm  W29

5 x - 932138

M20 DIN 934  W31

1 x - 930629

M20 DIN 6334  W32

1 x - 932143

M8 DIN 934  W33

12 x - 930233

M5 DIN 934  W34

30 x - 930231

M8 DIN 6334  W35

4 x - 930679

M6 DIN 562  W37

46 x - 932142

M8 x 55 mm  W38

3 x - 931733

M8 x 80 mm  W39

1 x - 932144

M8 x 70mm DIN 933  W40

3 x - 931735

M8 x 55mm DIN 6912  W41

6 x - 931879

M5 x 20mm DIN 7991  W42

30 x - 932139

M6 x 6mm DIN 914  W43

46 x - 932141

ø6 x 50 mm  W44

10 x - 930684

ø6 x 30 mm  W45

10 x - 930685

ø3,9 x 16mm DIN 7504P  W46

60 x - 932140

ø4,5 x 25 mm  W47

126 x - 931752

ø30 mm M10 DIN 9021A  W48

10 x - 930600

ø16 mm M8 DIN 125A  W49

12 x - 930680

M8 x70 mm  W50

1 x - 931742

 W51

5 x - 933025

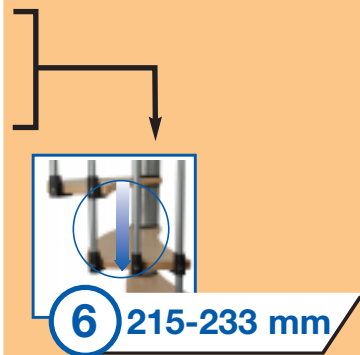
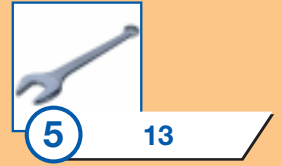
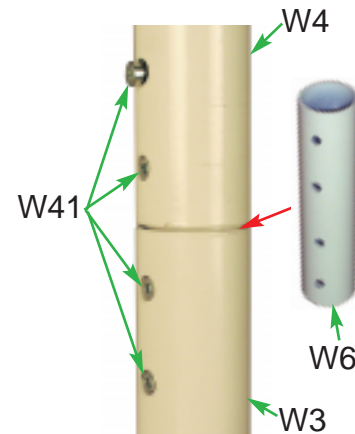
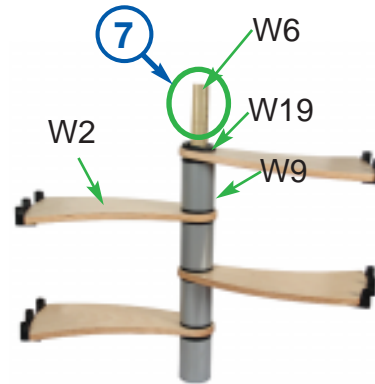
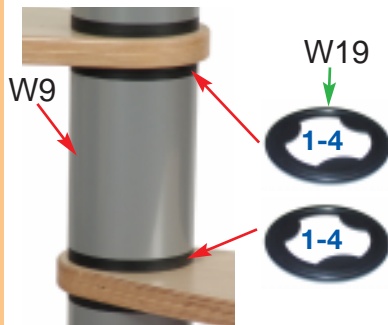
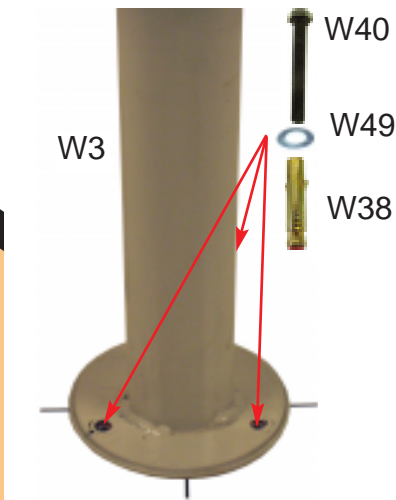
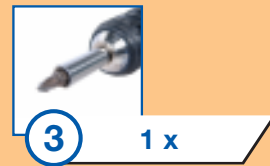
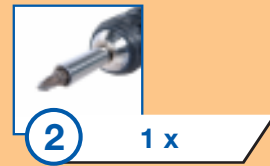
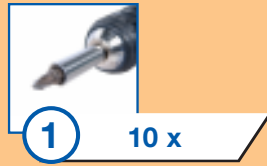
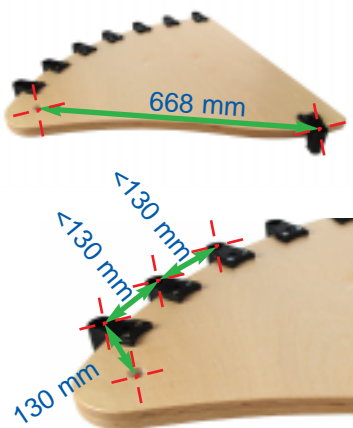
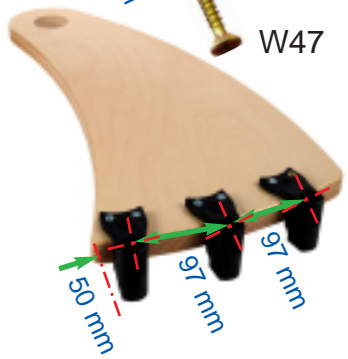
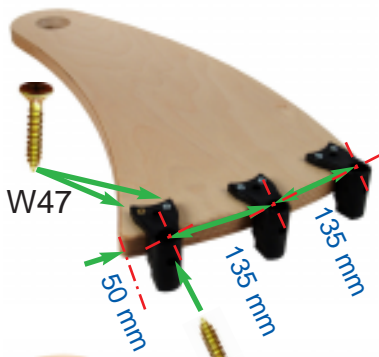
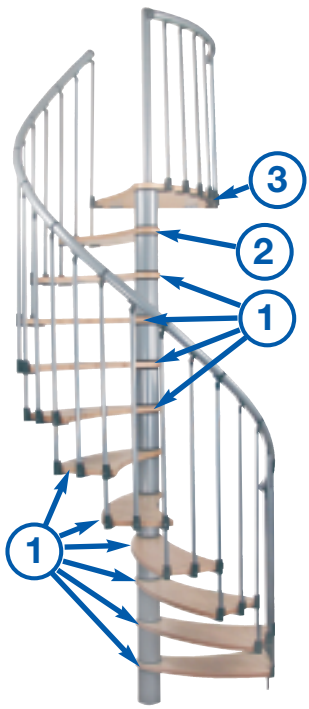

2 x W19 = 215 mm

3 x W19 = 218 mm

4 x W19 = 221 mm

5 x W19 = 224 mm

6 x W19 = 227 mm

7 x W19 = 230 mm

8 x W19 = 233 mm

